

Fasad Väster

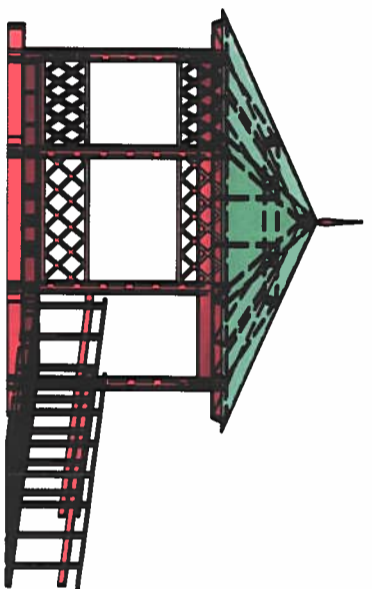

Fasad Norr

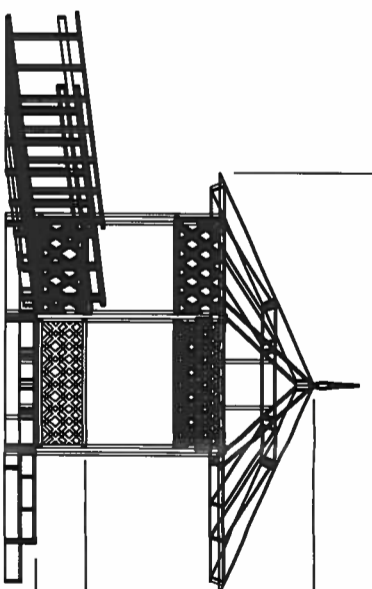

Fasad Öster

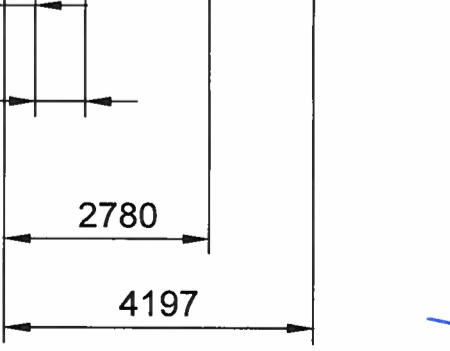

B ↓

↓ B

A ↓

↓ A

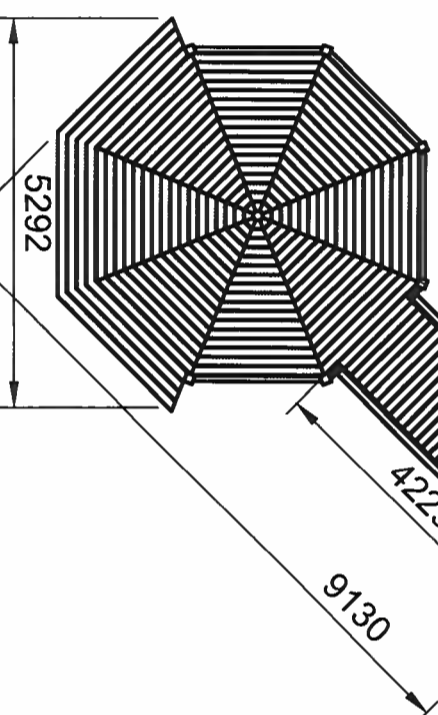
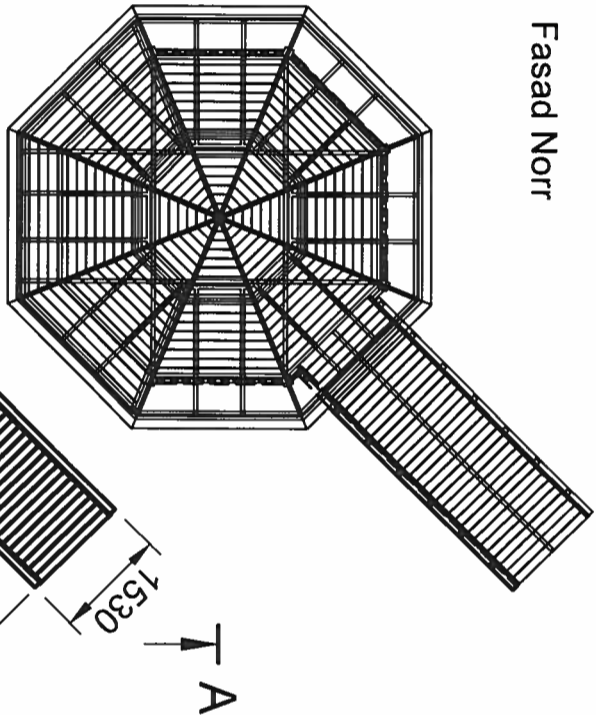

Sektion B Ovan

Sektion A Fram

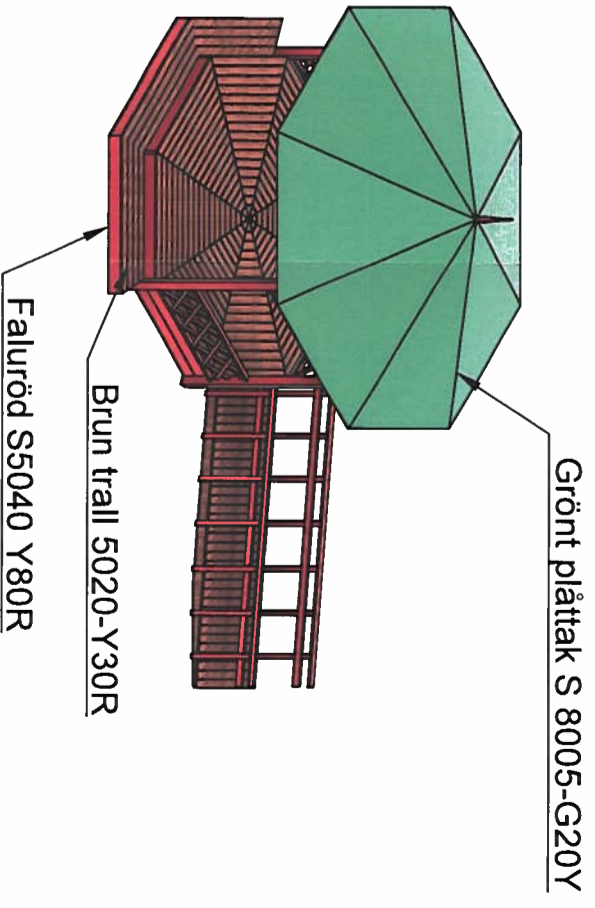
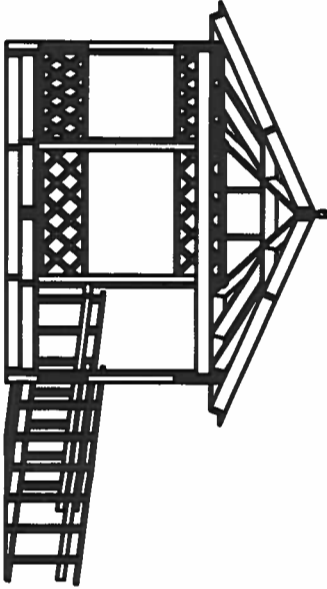

| | | | |
|-------|---------------------|----------------------|-----------------|
| Dept. | Technical reference | Created by | Approved by |
| | | Lekverket | |
| | | 2019-05-10 | |
| | | Document type | Document status |
| | | Järtas U18 Paviljong | |
| | | DWG No. | |
| | | Rev. | Date of issue |
| | | | Sheet |
| | | | 1/1 |

